

EC motors type G6

Servomotors with embedded electronics

Way of control

Servo motors type G6 works in positional, velocity and torque mode. Setting, driving and diagnostics of motor is provided through serial communications interface RS232 / RS 485 or CAN.

- Easy an open communication protocol
- Commands for control motion: mode selection, target position, velocity, acceleration, PID regulator constants, etc.
- Commands for backward reading of parameters and motor state as current, temperature, status word, etc.
- Motion parameters can be changed during motion

User program

User program is one or more commands sequence defined by user and written down to motor. These sequences can be executed by communication link or by changing input signal.

- Commands for parameter setting and motion control
- User variables and bits definitions
- Conditional branch, subprograms, time lag, commands for driving IO modules, etc.
- Up to two command threads solved simultaneously and independent of each other, e.g. logical function of machine and trajectory solving
- User program can be stored in EEPROM memory
- Program autostart after power up the motor

These features allow control complete mechanical node only by using IO pins, without communication link

Example of user program

```

; Test PID2
; příklad testovacího programu pro seřízení PID
; definice konstant
CONST Pos_xx = 10550[DEG]; pozice kam jezdit
CONST Vel_xx = 1000[RPM]; Rychlá rychlost
CONST Vel_yy = 350[RPM]; Pomalá rychlost
; nulování pozice a prepnutí na polohový mod
PosTest:
ACC = 100; zrychlení pro začátek
DEC = 200; zpomalení
CLEAR_VEL; zástav
WAIT (100); pro jistotu počkej
CLEAR_POS; tahla poloha !S 0 !!!
MODE = POSITION; přepni do polohové regulace
WAIT (1000); pro jistotu počkej
VEL = Vel_xx;
; cykl pohyb sem tam kolem nulu v polohovém režimu
; MovePos: ;Rozjede motor
VEL = Vel_xx; rychle tam
POS = -Pos_xx; pohyb tam
WAIT (200); počkej
VEL = Vel_yy; zpomal
WAIT (650); počkej
SCOPE = ExtStart; spust mereni osciloskopu
VEL = Vel_xx; rychle zpet
POS = Pos_xx; pohyb sem
WAIT (200); počkej
VEL = Vel_yy; zpomal
WAIT (650); počkej v koncové poloze
JUMP (_MovePos); opakuji znovu
END;
    
```

ECMotor Control – Graphics User Interface

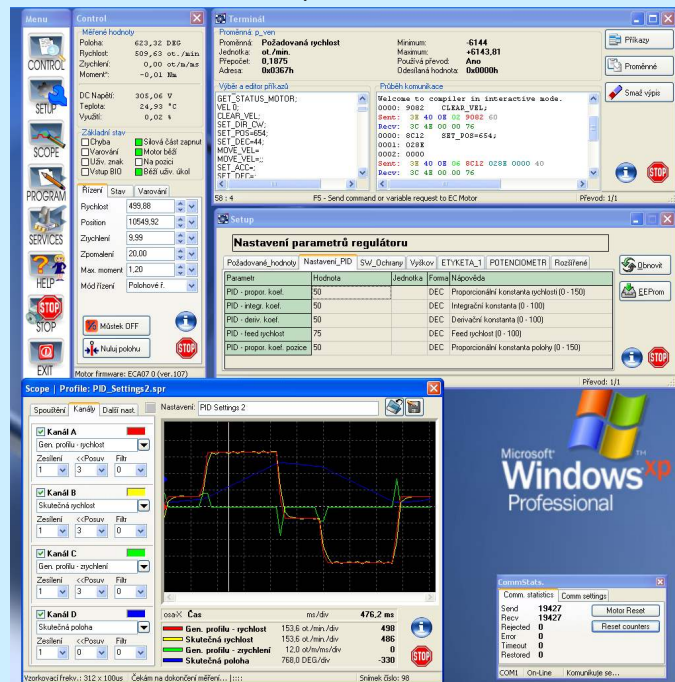

Configuration and diagnostic – EC Motor Control

Motor configuration and user program developing is provided on PC by program with graphic user interface.

- Easy and quick start to motion control
- Monitoring operation parameters
- Motor setting – PID, protection, etc.
- Oscilloscope for PID setting and driving diagnostics
- User program developing
- Command terminal – tool for commands explanation and communication protocol implementation
- Display state and setting of IO modules
- Upgrade firmware of motor and IO modules

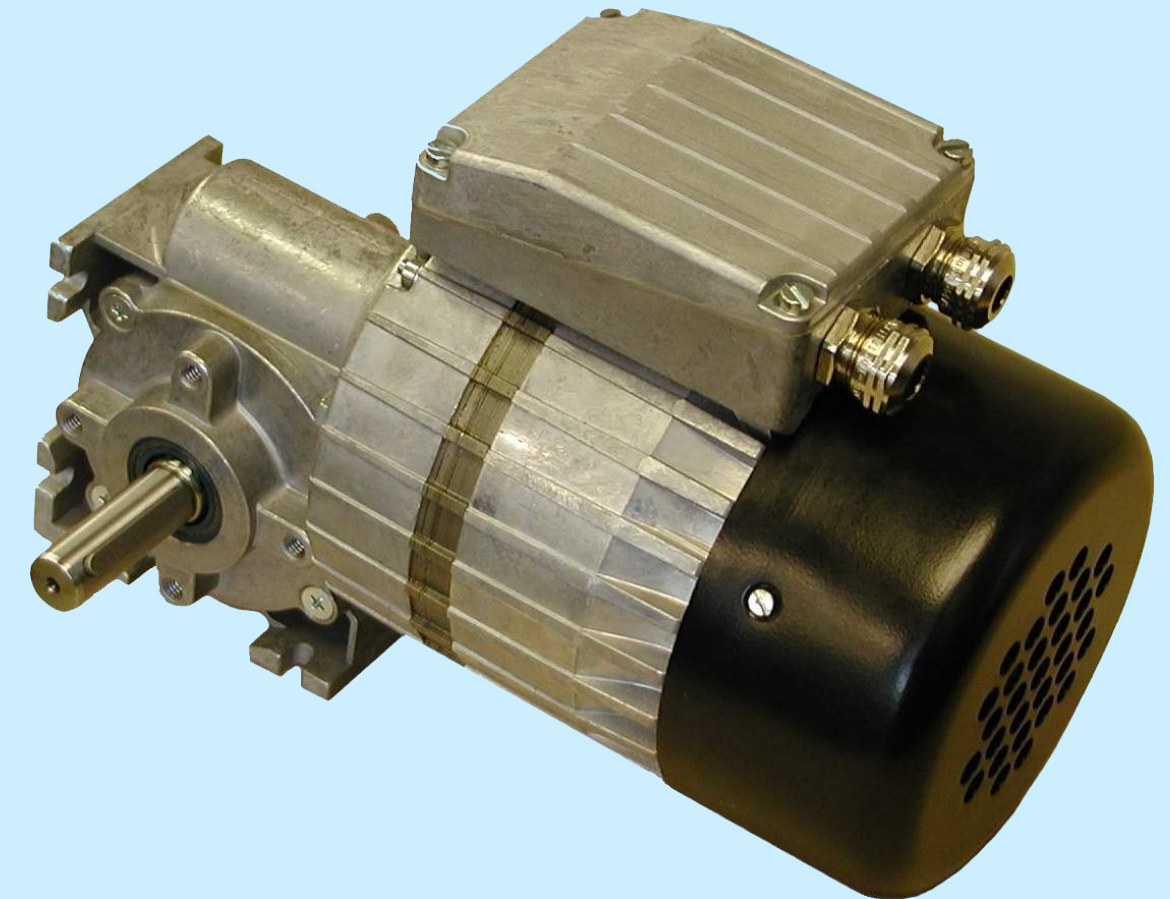

All you are looking for is inside

Producer of electronic and software:

PMControl s.r.o.
 Krásnohorské 994
 547 01 Náchod
 Czech Republic
 Tel.: +420 491 424 821
 Fax.: +420 491 424 821
 e-mail: info@pmcontrol.cz
 http:// www.pmcontrol.cz

Producer of electromotors:

ATAS elektromotory Náchod a.s.
 Bratří Čapků 722
 547 30 Náchod
 Czech Republic
 Tel.: +420 491 446 111
 Fax.: +420 491 423 946
 e-mail: marketing@atas.cz
 http:// www.atas.cz



Servo motor with emedded electronics - product line G6

Conception of motor type G6 that follows worldwide trend in control systems of motion driving. In one unit is fully integrated electromechanical parts, position sensor, control and power electronics, optional logic controller (PLC). Advantages of this solution are evident with complex look at development, design, manufacturing, maintenance and repairing of the drive.

Cost reduction along design

- lower expenses with construction (one unit, simple connection)
- solution of complex mechanical tag (IO modul, user program)
- minimum problems with EMC (all is one metal shielded cabinet)
- machine space saving

Cost reduction while assembly

- lower expenses with assembly and setting
- faster assembly and setting
- fewer possibilities for wiring errors
- saving link cable and connector

Cost reduction during operation life

- high efficiency
- long lifetime
- maintenance free
- easy diagnostics – PC program
- logistics – only one stock lot
- field service – replacement, minimal down time

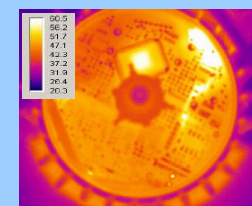

Motor type G6 is drawn as closed face-mounted 6 polar with permanent magnet based on noble mould (Nd-Fe-B) at rotor. Integrated power stage and control electronics provides function of vector controlled servo drive. Built-in absolute position sensor remove random move the rotor during powering up. Compact metal covering ensures resistivity against external

interference and minimize self radiation. For industrial environment accordance with EN 55022 B class there are not needed another anti-interference parts.

Motors type G6 are intended for drive where dont oblige combination of induction motor with frequency converter and usage of classical servomotors or stepper motors is from economical reasons disadvantageous.

Advantages of motors type G6 as compared with induction motor with frequency converter

- position feedback
- torque from zero velocity
- torque overload
- higher efficiency

Advantages of motors type G6 as compared with stepper motor

- large range of regulation
- better dynamic features
- without loss of step
- higher efficiency
- minimum still current

Advantages of motors type G6 as compared with servomotor

- lower price
- less machine space required
- better electromagnetic compatibility
- self cooling

Gear – box

- standard flange IM B14/71
- worm-gear unit rate 6,75 – 40 torque up to 36 Nm

Motor

- power range up to 600W
- velocity up to 6000 RPM
- continual torque up to 4Nm
- peak torque up to 7Nm
- overload capacity up to 2,5 times
- efficiency up to 85%
- insulating class F
- self cooling
- protection class IP54
- long lifetime
- maximum reliability

Power section

- supply 110 – 230V AC
- internal ballast resistor
- PFC correction
- EMC compatibility
- overcurrent protection, overvoltage protection, undervoltage protection, overloading protection, temperature protection, position error protection

Controller

- position mode
- velocity mode
- torque mode
- 16bit digital servo vector control, sinus PWM, PID position regulator
- user program
- upgrade firmware

Position sensor

- absolute sensor
- 3072 pulses/revolution
- ±0,8° accuracy
- ±0,1° repeatability
- max. 10.000 RPM

IO modules

- replaceable modules
- galvanic isolation
- communication RS232, RS485, CAN
- progr. logic controller logical outputs – 24V
- logical inputs – 5/24V
- analog inputs – 5/10V
- DC supply 12V/60mA

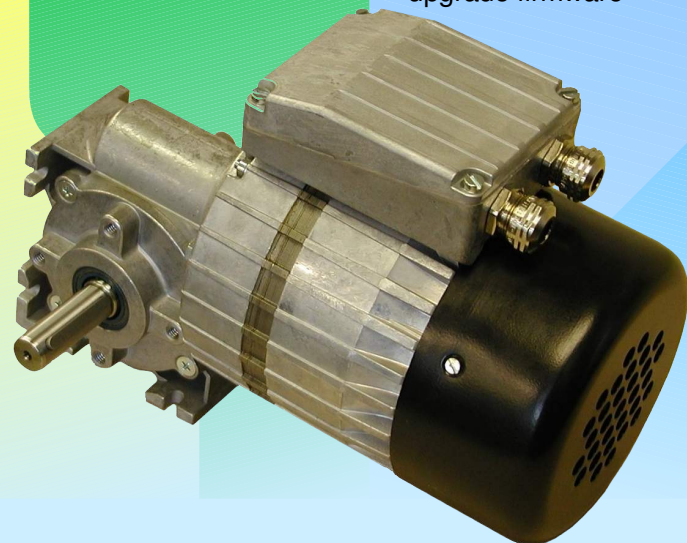

Motor type	G62UF311	G62UF314	G62UL306	G62UL327	G66UF308 ¹
Rated motor velocity [RPM]	3500	1500	3500	1500	120
Maximum motor velocity [RPM]	4000	2000	4000	2000	120
Continual torque [Nm]	0,8	1,0	1,6	1,9	15
Peak torque [Nm]	3,2	3,7	3,5	7,0	20
Rated power [W]	300	150	600	300	190
Physical dimensions ø x l [mm]	120 x 150	120 x 150	120 x 165	120 x 165	120 x 246
Weight [kg]	3,3	3,3	4,0	4,0	5,3

1) performance with worm-gear unit 1:30

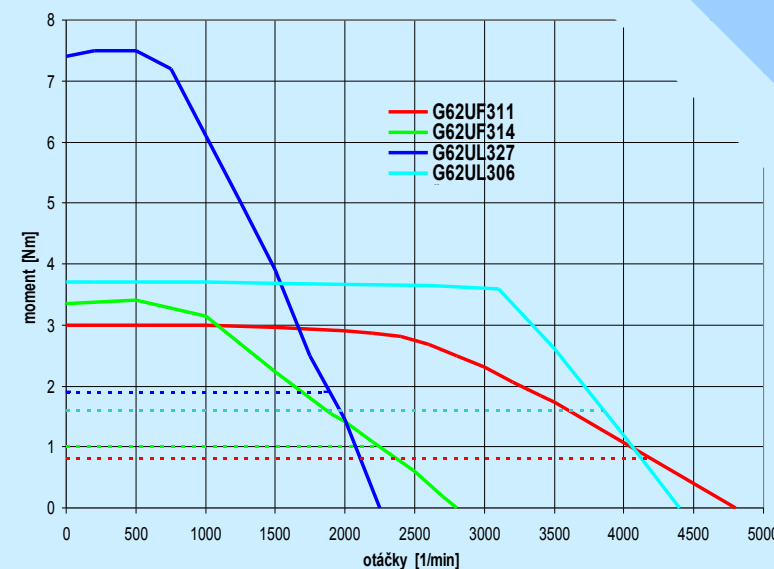
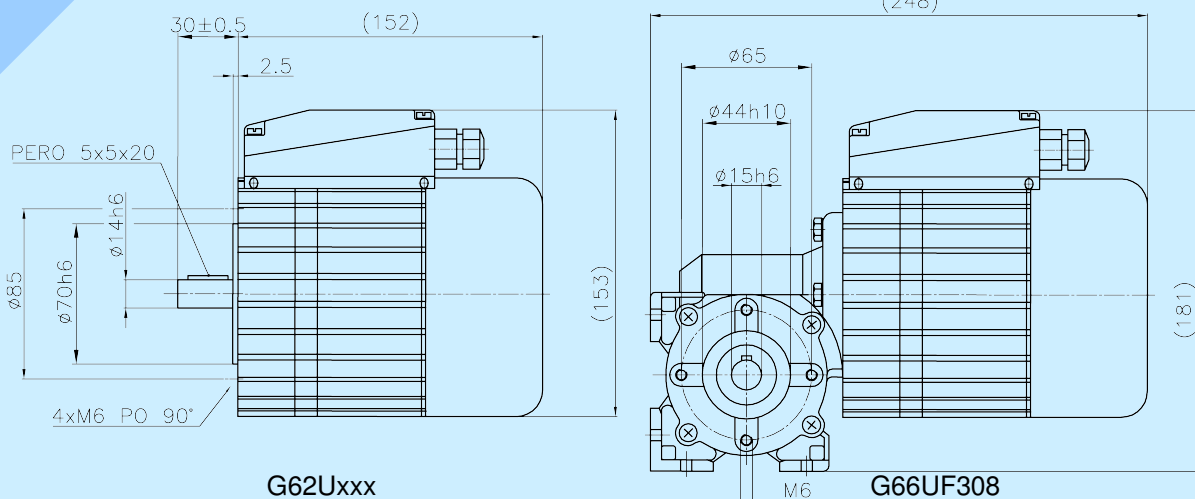

Work area of motors type G6

Example of usage

- material movers and cutters
- takedown transporters
- stockroom collators
- turntables
- toolholders
- packing machines
- mix and filling machines
- label aplicators
- printing machines
- exact pumps and ventilators
- drivers of regulation ventils
- winding drivers
- spray and welding automats

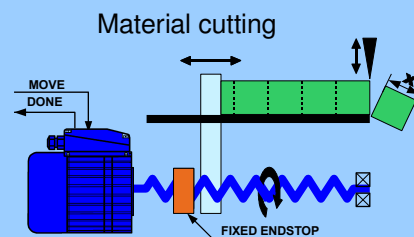

IO module type	EC100	EC110	EC113	EC202
RS232/RS485	1/-	1/-	1/-	1/1
CAN	-	-	1	1
programable automat	-	-	-	8 bit
logical inputs 5/24V	1	2	2	9 ¹
logical outputs 24V	-	1 50mA	1 50mA	4 ¹ 250mA
analog inputs ±5/10V	-	1 12bit	-	4 ¹ 10bit
internal supply 12V 60mA	-	(1)	(1)	1

1) total number of pins is limited – function is selectable

